



NEWAGE[®]
FIRE FIGHTING CO. LTD.

Protection with Reliability and Trust



2018 - 19
Edition

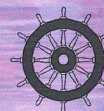

An Introduction To NewAge

Consisting of...



NewAge® was founded in the year of 1960 at Surendranagar, Gujarat and it has more than 5 decades of experience of manufacturing various kinds of Fire Fighting Equipments and Fire Hoses. **NewAge®** Group has the factories spread over 50,000 sq. mtr. at Surendranagar. It has its regional offices in New Delhi, Ahmedabad, Pune, Chennai, Kochi, Vadodara, Kolkata and Bangalore. **NewAge®** also sells its equipment's through its efficient network of Distributors throughout India. Since last 45 years **NewAge®** is selling its product abroad as well and today exports the products to about 60 countries. Since its inception, **NewAge®** has grown to become the only manufacturer in the subcontinent to provide the complete range of Fire Fighting Equipments starting from Fire hoses, Hydrants, Water Foam Monitors, Foam Equipments to Fire Fighting Portable Pumps, Trailer Fire Pumps and Fire Vehicles and is indisputably the leading manufacturer of these products. It is considered a benchmark in the fire industry due to its consistent and quality based principle.

NewAge® group has acquired Jayshree Textiles – a division of India Rayon Corpn., Aditya Birla Group in 2003 and Hose division of one of the other International Co. in 2007 making **NewAge®** Group, Asia's largest production for the Fire Fighting Hoses with daily production capacity of 20,000 meters. **NewAge®** Group of Companies are backward integrated and fully self reliant for its production activities with own Foundry and Machine Shop with daily casting capacity of 2,000 Kilograms.

NewAge® has been a regular supplier of approved quality goods to sectors like Oil and Gas, Chemical and Fertilizer, Power Plants, Aviation Industry, Construction, Port Trusts, Defense Establishments and other industries.

The group of companies employs about 500 people. It is a regular recipient of Export Excellence Awards for exporting the product to countries like Singapore, Malaysia, Kuwait, Myanmar, Indonesia, United Kingdom, Italy, Germany, Denmark, Belgium, Greece, Canada, Ireland, United States of America, South Africa, United Arab Emirates, Philippines etc.



Table of Contents

1	Introduction	2
2	Table of Contents	3
3	Quality Assurance	4
4	Vision / Mission	5
5	Trademark Certificate	6
6	ISO Certificate	7
7	Fire Hose	8
8	Delivery Hose Coupling / Adaptors & Caps	9
9	Adaptors & Caps / Collecting Dividing	10
10	Branch Pipe / Nozzle	11
11	Pistol Grip Nozzle / Hydrant Valves	12
12	Hydrant Valves / Pressure Controlled Devices	13
13	Dry Riser Fittings / Gate Valve	14
14	Butterfly Valve / Hose Box / Hose Reel & Accessories	15
15	Hose Reel & Accessories / Stand Post Type Hydrants	16
16	Stand Post Type Hydrants / Water Spray Nozzles	17
17	Sprinkler, Flexible Hose & Alarm Valve / Foam Equipment	18
18	Monitors	20
19	Monitor Nozzle / Pump	21
20	Pumps / Fire Vehicle Pump / Portable Fire Pumps	22
21	Accessories / Miscellaneous Equipments	23
22	Skid Mounted Equipments	24
23	Smoke Extractor & Blower/ Rescue Equipment / Lifting Tools	25
24	Fire Vehicles	26
25	Fire Vehicles / Special Purpose Vehicles	27



Quality & COMPLIANCE

At **NewAge**[®] Group, when it comes to fire protection of people and property, there is no scope for error because we believe it's our responsibility to be the good stewards of safety. For complete customer satisfaction and safety, quality is ingrained in our work and our values.

Since its inception, the Company endeavors to continually and effectively improve the quality of its products and services in accordance with the International standards. As a part of our quality policy, our fire equipment meet the ISO 9001:2008 guidelines and we are accredited by numerous National and International regulatory bodies for the remarkable quality of our work. At each phase of production, our quality control personal rigorously tests and examines the performance and durability to present our customers with the finest portfolio of products. At **NewAge**[®], we have a relentless passion for quality as we aim to make the community, a safer and better place to live.

Customer Satisfaction

- ◆ Product Quality
- ◆ On-Time Delivery
- ◆ Quick Response
- ◆ Inventory Stocking
- ◆ Value Added Services
- ◆ Online Support
- ◆ Delivery Reliability

Operational Excellence

- ◆ Lean Management
- ◆ Product Design
- ◆ Real Time Operation
- ◆ ERP System Efficiency
- ◆ Effective Sales Management
- ◆ Efficient Logistics Management
- ◆ Continuous Improvement

Competitiveness

- ◆ Strategic Procurement
- ◆ Integrated Manufacturing Network
- ◆ Vertical Integration Assemblies
- ◆ Innovation of Products New Emerging
- ◆ Manufacturing Technologies

Vision Statement

- ◆ To Acquire and maintain global leadership position in chosen areas of businesses
- ◆ To continuously create new opportunities for growth in our strategic businesses
- ◆ To remain the top 10 most admired companies to work for in the industry

INTEGRITY
Ethics, trust, fairness,
transparency and honesty

TEAM WORK
Thriving through strong teamwork,
learning and development in a
supportive and fun culture

PASSION FOR EXCELLENCE
Relentless pursuit towards
achieving better results every time

COLLABORATION
Power of working together

QUALITY
Dedication to delivering quality
and value to customers, with
pragmatism and independence

SUSTAIN ABILITY
Understand the bigger picture
and add value to the bottom line

INNOVATION
Making a difference through
creativity

CLIENT VALUE CREATION
Designing quantum leaps for the
Client's Business

Values

Trade Mark Certificate

प्रारूप ओ - 2
FORM O-2



सत्यमेव जयते

भारत सरकार

GOVERNMENT OF INDIA

व्यापार चिन्ह रजिस्ट्री

TRADE MARKS REGISTRY



बौद्धिक सम्पदा, भारत
Intellectual Property, India

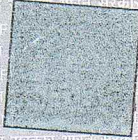

क्रमांक
No.

1176918

व्यापार चिन्ह अधिनियम, 1999

Trade Marks Act, 1999

व्यापार चिन्ह के रजिस्ट्रीकरण का प्रमाणपत्र, धारा 23 (2) नियम 62 (I)

Certificate of Registration of Trade Mark, Section 23 (2), Rule 62 (1)

व्यापार चिन्ह संख्या / Trade Mark No.

2192724

दिनांक / Date

19/08/2011

ज.संख्या / J.No.

1609

यह प्रमाणित किया जाता है कि जिस प्रकार चिन्ह की समाकृति इसके साथ संलग्न है, वह
के बारे में दिनांक

नाम से रजिस्ट्रीकृत हो चुका है।

Certified that the Trade Mark / a representation is annexed hereto, has been registered in the name(s) of

SHRI JIMIT MAHESHKUMAR SHAH, AMBAWADI INDUSTRIAL ESTATE, SURENDRANAGAR - 363 001 - GUJARAT,
SHRI ASHOKKUMAR MAHIPATLAL SHAH, SHRI NISHA JIGNESH SHAH, SHRI HEMANTKUMAR MAHIPATLAL SHAH,
AN INDIAN NATIONAL PARTNERSHIP FIRM, Trading as : NEWAGE INDUSTRIES, MANUFACTURER AND
MERCHANT, (Partnership Firm)

In Class

9

Under No.

2192724

as of the Date

19 August 2011

in respect of

FIRE FIGHTING AND SAFETY TOOLS, APPLIANCES, ACCESSORIES, EQUIPMENTS AND FABRICATED
STRUCTURES OF FIRE FIGHTING VEHICLES INCLUDED IN CLASS-09.



NEWAGE

के निदेश पर आज के मास के वे दिन को इस पर मुद्रा लगायी गई।

Sealed at my direction, this 07th day of July, 2014

Rizwan

व्यापार चिन्ह रजिस्ट्री,
Trade Marks Registry AHMEDABAD

Charitaga

व्यापार चिन्ह रजिस्ट्रार
Registrar of Trade Marks

रजिस्ट्रीकरण आवेदन की तारीख से 10 वर्ष के लिए है और तदुपरान्त वह 10 वर्ष की कालावधि के लिए और प्रत्येक 10 वर्ष की कालावधि के अवसान पर भी नवीनीकृत किया जा सकेगा।
Registration is for 10 years from the date of application and may then be renewed for a period of 10 years and also at the expiration of each period of 10 years.

यह प्रमाणपत्र विधि कार्यवाहियों में प्रयोग के लिये या विदेश में रजिस्ट्रीकरण अभिप्राप्त करने के लिये नहीं है।
This certificate is not for use in Legal proceedings or for obtaining Registration abroad.

टिप्पणी - इस व्यापार चिन्ह के स्वामित्व में कोई परिवर्तन होने पर, या कारोबार के मुख्य स्थान के पते में या भारत में तामील के लिये पते में परिवर्तन होने पर परिवर्तन के लिये आवेदन
तुरन्त किया जाना चाहिये।
Note : Upon any change of ownership of this Trade Mark, or change in address, of the principal place of business or address for service in India a request should
AT ONCE be made to register the change.

BUREAU VERITAS
Certification



NEW AGE FIRE FIGHTING CO. LTD.



PLOT NO. 86, 87, 93, 94, GIDC PHASE-I, LMS COMPOUND,
WADHWAN CITY – 363 030, GUJARAT, INDIA.

Bureau Veritas Certification Holding SAS – UK Branch certifies that the Management System of the above organization has been audited and found to be in accordance with the requirements of the Management System standard detailed below.

Standard

ISO 9001:2015

Scope of certification

MANUFACTURE AND SUPPLY OF FIRE HOSE & FIRE FIGHTING EQUIPMENT

Original cycle start date: **22 August 2018**

Expiry date of previous cycle: **NA**

Certification Audit date: **26 July 2018**

Certification cycle start date: **22 August 2018**

Subject to the continued satisfactory operation of the organization's Management System, this certificate expires on: **21 August 2021**

Certificate No. **IND18.2217 U/Q** Version : 1

Revision date: **22 August 2018**

Signed on behalf of BVCH SAS – UK Branch
Ramesh KOREGAVE
Director, CERTIFICATION
South Asia Region



Certification body address: **5th Floor, 66 Prescott Street, London, E1 8HG, United Kingdom.**

Local office: **Bureau Veritas (India) Private Limited (Certification Business)**
72 Business Park, Marol Industrial Area, MIDC Cross Road "C",
Andheri (East), Mumbai – 400 093, India.

Further clarifications regarding the scope of this certificate and the applicability of the management system requirements may be obtained by consulting the organization. To check this certificate validity please call +91 22 6274 2000.

Fire Hose



Premier Extra
NFF-FH-PE



Pyroprotect
NFF-FH-PY



Premier
NFF-FH-PR



Hydroline
NFF-FH-HL



Premier DJ
NFF-FH-PDJ

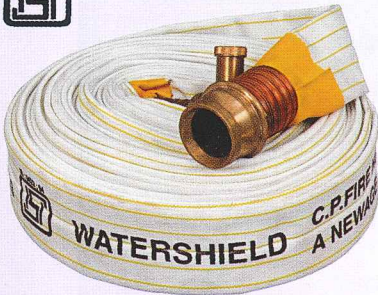

Water Shield
NFF-FH-WS



Pyrofrac (Large Dia Hose)
(8", 10", 12")
NFF-FH-PYF

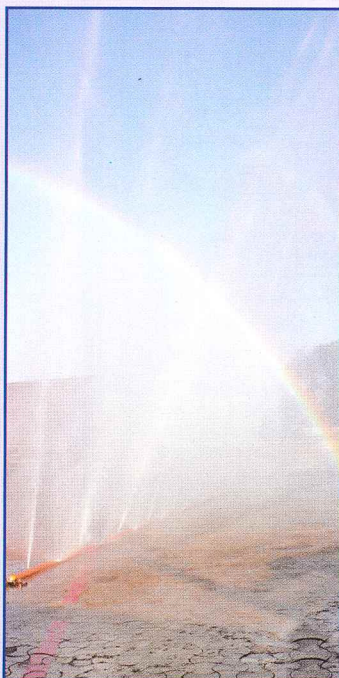

Pyrojet
NFF-FH-PJ



**Reduced Shank
NFF-CP-RIC**



**Instantaneous Type Coupling
NFF-CP-IS**



**Storz Coupling
NFF-CP-STR**



**Russian Standard Gost Coupling
NFF-CP-RSG**



**American Rocker LUG
NFF-CP-AR**

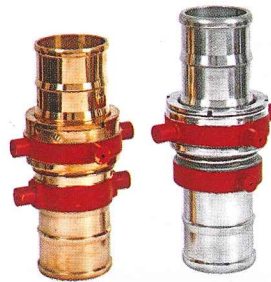

**Suction Coupling
NFF-CP-SC**

Adaptors & Blank Cap

NFF - ADP & NFF - BC

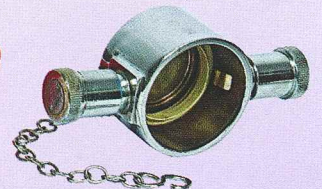
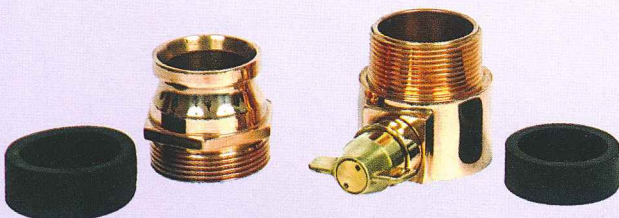

Adaptors & Blank Cap

NFF - ADP & NFF - BC

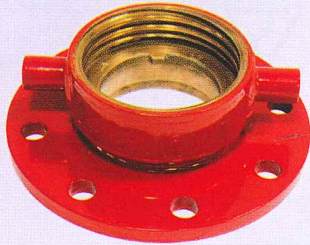

Draw Out Connection
NFF-FT-DCT

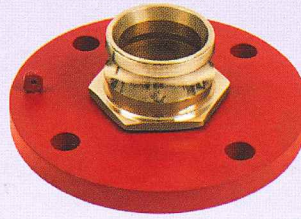

Draw Out Connection
NFF-FT-DCI



Shore Connection
NFF-FT-DC



BSRT Pumper Connection
NFF-FT-PC

Collecting & Dividing Breeching

NFF - FT - CB & NFF - FT - DB

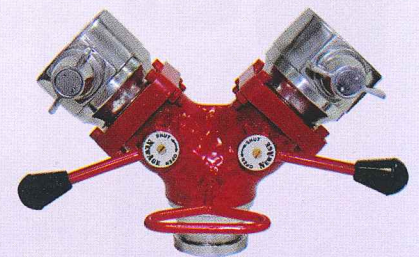
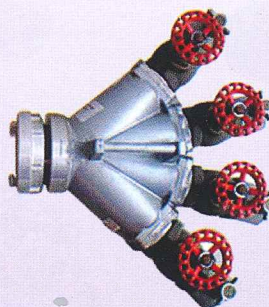



Portable Spray Nozzle
NewAge-NZ-38 / 65



Short Branch Pipe
NFF-BP-SB



Long Branch Pipe
NFF-BP-LB



Triple Purpose
NFF-BP-TP



Navy Diffuser
NFF-BP-ND



3 - Position Nozzle
NFF-BP-3P

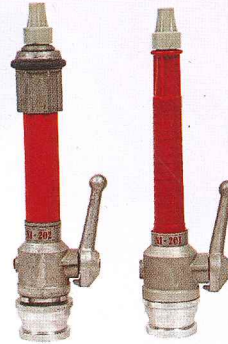

Hand Controlled
Branch Pipe
NFF-BP-HCB



Diffuser Nozzle
NFF-BP-DN



Navy Diffuser Nozzle
NFF-BP-NDN



Combat Nozzle
NFF-BP-CM

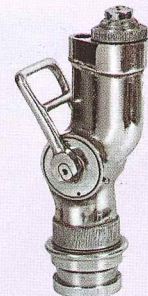

Fog Nozzle
NFF-BP-FM



Revolving Branch
NFF-BP-RB

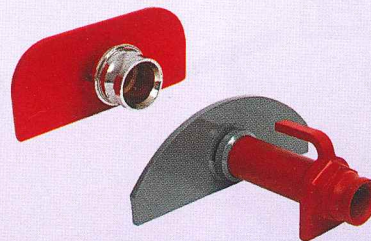

Curtain Nozzle
NFF-BP-CN

Pistol Grip Nozzle



BOWfire Nozzle
NFF-NZ-BFN



SUPERfire Nozzle
NFF-NZ-SFN



CONfire Nozzle
NFF-NZ-CFN



RAPIDfire Nozzle
NFF-NZ-RFN



HAWKfire Nozzle
NFF-NZ-HFN



JETfire Nozzle
NFF-NZ-JFN

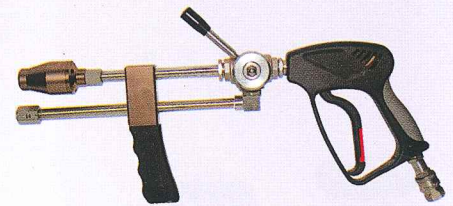

PINfire Nozzle
NFF-NZ-PFN

Hydrant Valves



Oblique Flanged
NFF-LV-FM



Oblique Flanged (Gunmetal)
NFF-LV-OBF



Oblique Flanged (S.S.)
NFF-LV-OBF

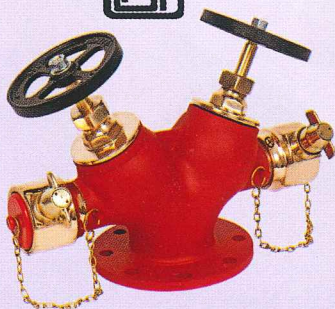

Double Headed Hydrant (Gunmetal)
NFF-LV-DOT

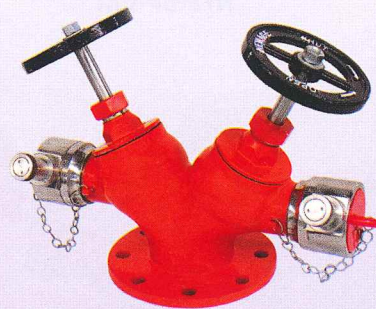

Double Headed Hydrant (S.S.)
NFF-LV-DOT



Oblique Threaded
NFF-LV-OBT



Bib Nose Flanged
NFF-LV-BNF



Turn Down Flanged
NFF-LV-TDF



Right Angled Flanged
NFF-LV-RAF



Straight Threaded
NFF-LV-STT



Gate Valve
NFF-LV-GV

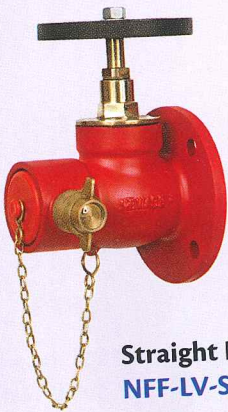

Straight Flanged
NFF-LV-STF



Hose Valve
NewAge-38 / 65

Pressure Controlled Devices



Pressure Restricting Valve
NFF-LV-PRT

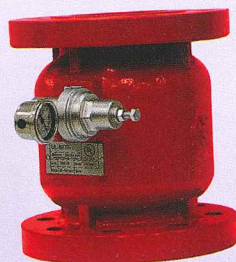

Pressure Reducing Valve
NFF-LV-PRDV

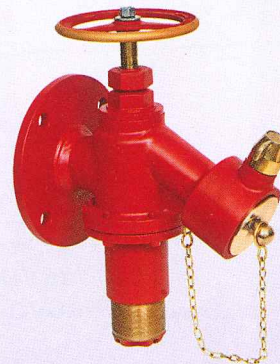

Pressure Reducing Valve
NFF-LV-PRV



Dry Riser Fittings



**Two Way Inlet Breaching
NFF-DRE-2W**

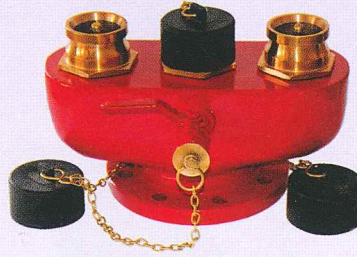

**Three Way Inlet Breaching
NFF-DRE-3W**

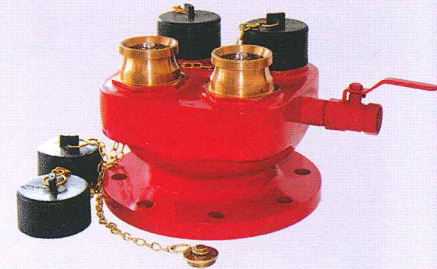

**Four Way Inlet Breaching
NFF-DRE-4W**

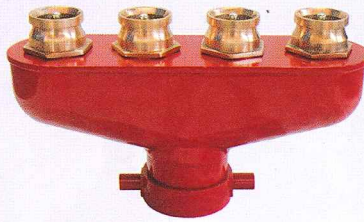

**Four Way Inlet Breaching
NFF-DRE-4W**



**Air Release Valve
NFF-ARV**

Gate Valves



**200 PSI - OS & Y Type
Flanged End Gate Valve
NI-GVO-200FF**

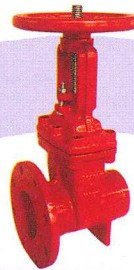

**200 PSI - OS & Y Type
Flanged End Gate Valve
NI-GVO-200FG**



**200 PSI - OS & Y Type
Grooved End Gate Valve
NI-GVO-200GG**



**200 PSI - NRS Type Flanged End
Gate Valve with Round Plate
NI-GVN-200FF**



**200 PSI - NRS Type Grooved
Gate Valve
NI-GVO-200GG**

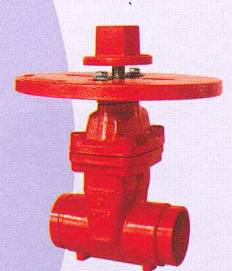

**200 PSI - NRS Type Grooved
End Gate Valve
NI-GVN-200GG**



**300 PSI - OS & Y Type Flanged End Gate Valve
NI-GVO-300FF**



**300 NRS Type Flanged End Gate Valve
NI-GVN-300FF**

Butterfly Valves

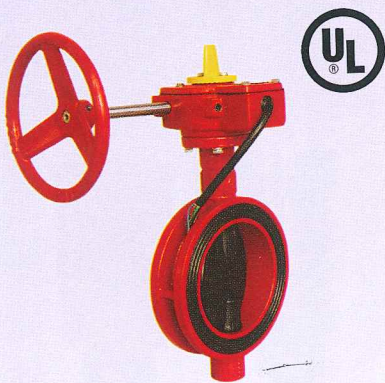

Wafer Type Butterfly Valve
NI-BVW

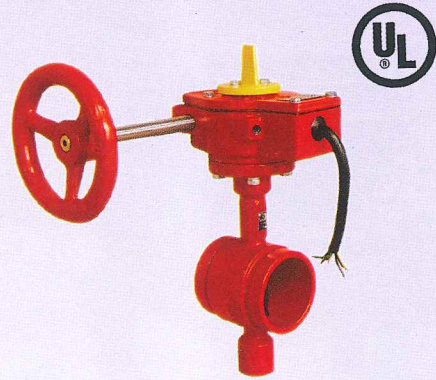

Groove Type Butterfly Valve
NI-BVG

Hose Box



Foam Station Cabinet
NFF-CB-FSC



Hose Cabinet
NFF-CB-HC



Stand Mounted Cabinet
NFF-CB-SMC



Hose Reel Cabinet
NFF-CB-HRC

Hose Reel & Accessories

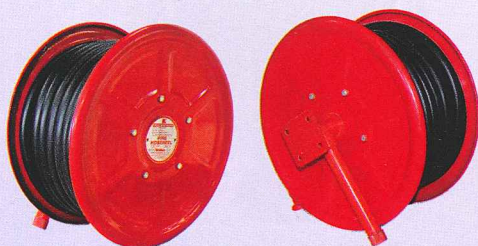

Fixed Type Hose Reel
NFF-HR-FT

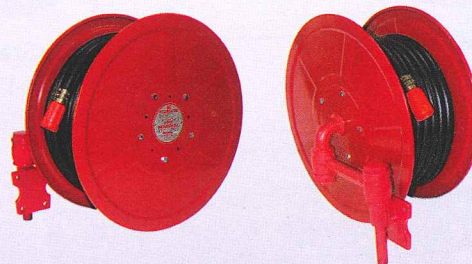

Swinging Type Wall Mounted
NFF-HR-WM

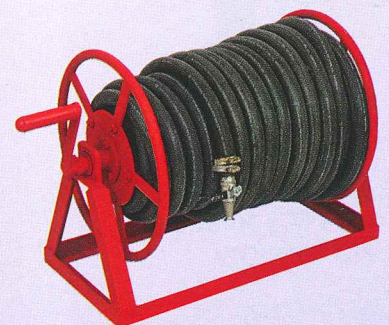

Stand Mounted
NFF-HR-SM

Hose Reel & Accessories



Hose Reel with Foam Tank
NFF-HR-FS



PVC Nozzle
NFF-HR-NZ-PVC



Gunmetal Nozzle
NFF-HR-NZ-GM



PVC Hose
NFF-HR-H-PVC



Rubber Hose
NFF-HR-H-R



Thermoplastic Hose
NFF-HR-H-T

Stand Post Type Hydrants



One Way Stand Post
NFF-SPH-OW



2 - Way Stand Post
NFF-SPH-TWF

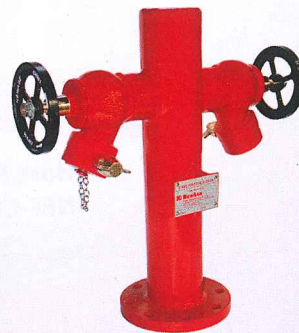

2 - Way Stand Post
NFF-SPH-TWT

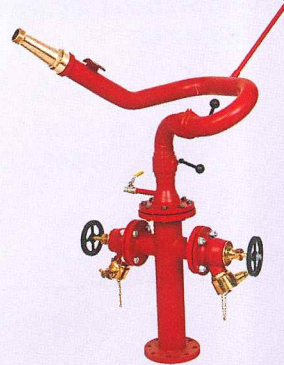

2 - Way Stand Post with Monitor
NFF-SPH-2WM

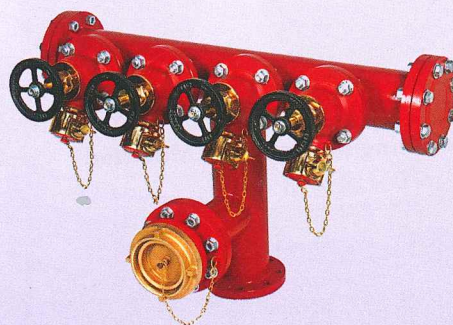

4 - Way Stand Post
NFF-SPH-4WF

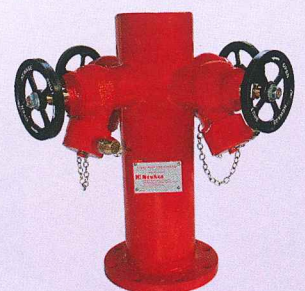

4 - Way Stand Post (Cross Arm Type)
NFF-SPH-4WCA

Stand Post Type Hydrants



Dry Barrel Pillar Hydrant
NFF-SPH-DB



Customized Stand Post



Surface Box
NFF-SPH-SB

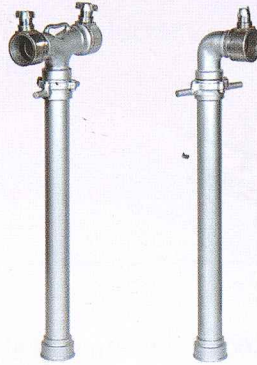

Stand Pipe
NFF-SPH-SP



Underground Fire Hydrant & Key
NFF-SPH-UG / SPH-UGK

Water Spray Nozzle



Medium Velocity Spray Nozzle
NFF-WSN-MVSN



High Velocity Spray Nozzle
NFF-WSN-HVSN



Tank Cooling Nozzle
NFF-WSN-TCN

Sprinkler Systems



Concealed Type
NS007 (SR) / NS008 (QR)

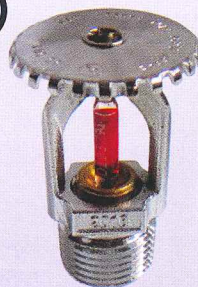

Upright Type
NS003 (SR)



Upright Type
NS004 (QR)

Sprinkler Systems



**Pendent Type
NS005 (SR)**



**Pendent Type
NS006 (QR)**



**Sidewall Type
NS017 (SR)**



**Sidewall Type
NS018 (QR)**

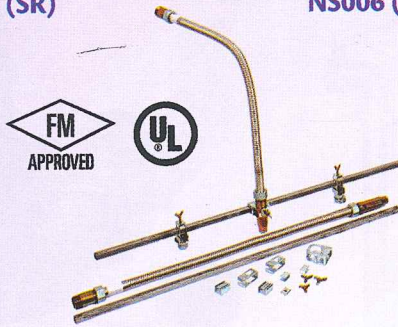

Flexible Hose

Braided 700mm/1000mm/1200mm/1500mm/1800mm (FM Approved)
Unbraided 700mm/1000mm/1200mm/1500mm/1800mm (UL Listed)

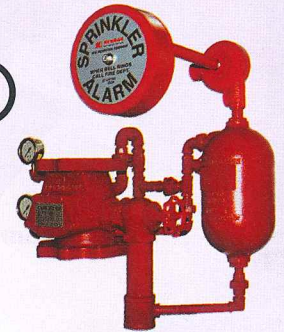

**Alarm Valve
NewAge-AV-4 / 6**

Foam Equipments

Foam Making Branch Pipes



**FB 2X, 10X
NFF-FE-FB (2X, 10X)**



**FB 20X
NFF-FE-FB (20X)**



**NewAge-FB-225-F
NewAge-FB-450-F**



**FB 5X
NFF-FE-FB5X**

Foam Generator

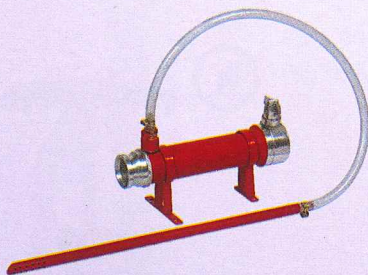

**Inline Foam Generator
NFF-FE-FGI**



**Medium Expansion Foam Generator
NFF-FE-MEFG**



**Hi-Ex Mini Generator (MK II)
NFF-FE-FGMK2**

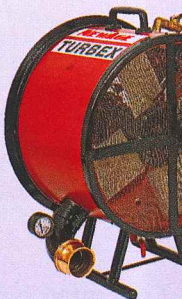

**Hi-Ex Mini Turbine
NFF-FE-FGMII**

Foam Inductors

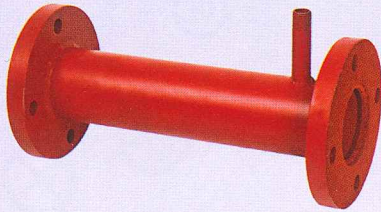

Fixed Inductor
NFF-FE-FID

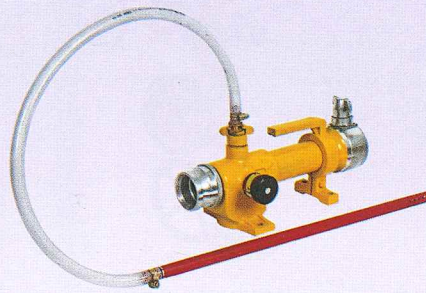

Variable Inline Inductor
NFF-FE-VID

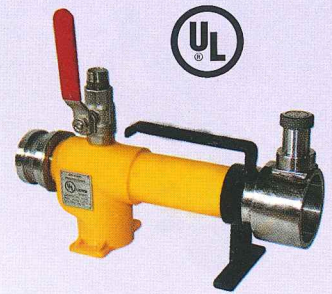

Inline Inductor
NewAge-ILI-225-F / 450-F

Foam Maker



Foam Maker without Vapor Seal Chamber
NFF-FE-FMWOVS

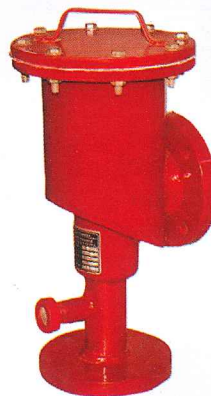

Foam Maker with Vapor Seal Chamber
NFF-FE-FMWVS



High Back Pressure Foam Maker
NFF-FE-HBPFM

Mobile Foam Unit



FRP Tank
NFF-FE-MFU-FRP



Stainless Steel Tank
NFF-FE-MFU-SS



Fast Attack Mobile Foam Unit
NFF-FE-MFU-FA

Monitors



Water Jet Monitor
NFF-M-WJN



Fixed Flow Monitor
UL Listed



Adjustable Flow Monitor
UL Listed



Long Range Water Monitor
NFF-M-LRHV



Stand Post Mounted Oscillating Monitor
NFF-M-OM



Trolley Mounted Monitor
NFF-M-TMM



Tower (Elevated Monitor)
NFF-M-EM

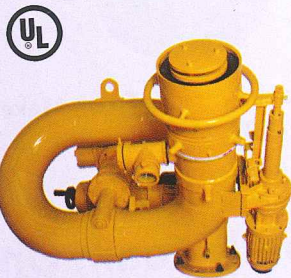

Fixed / Adjustable Flow Monitor
UL Listed



Control Panel
NFF-M-CP



Motor Operated Valve
NFF-M-MOV



Trolley Mounted Monitor with Tank
NFF-M-TMMWT



Trailer Mounted Monitor with Foam Tank
NFF-M-TMFT

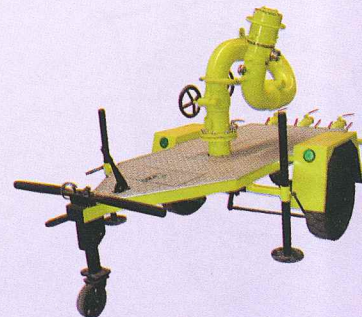

Trailer Mounted Monitor
NFF-M-TM

Monitor Nozzles



Jet Nozzle
NFF-MN-JN



Stackable Tips Jet Nozzle
NFF-MN-STJ



Aqua Foam Nozzle with Teeth
NFF-MN-AFN



Jet and Spray Nozzle
NFF-MN-JSN



Aqua Foam Nozzle
NFF-MN-AQF



Jet Ratio Controller
NFF-MN-JRCP

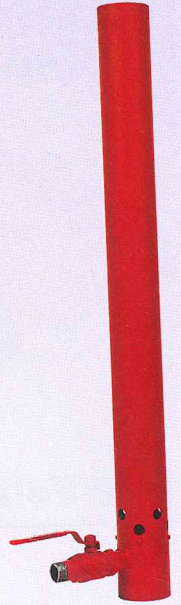

Foam Barrel
NFF-MN-FB

Pumps

Water Driven De-Watering



Adjustable Ejector Pump
NFF-PU-AEP



Ejector Pump
NFF-PU-EP



Turbo Pump
NFF-PU-TP

Trailer Mounted Pumps

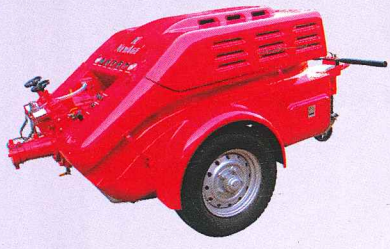

High Capacity Trailer Mounted Pump
NFF-PU-TM

Fire Vehicles Pumps

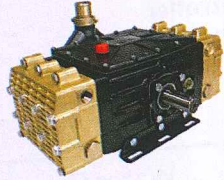
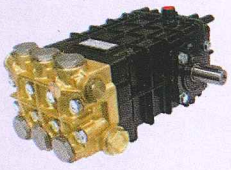

Ultra High Pressure Pump
(PTO Driven)
NFF-PU-UHP (PTO)

Fire Vehicle Pump
NFF-PU-VP

Ultra High Pressure Pump
(Engine Driven)
NFF-PU-UHP (Engine)

Portable Fire Pumps

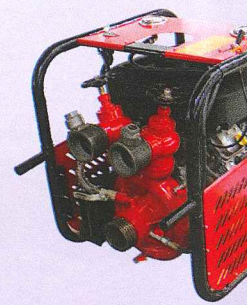
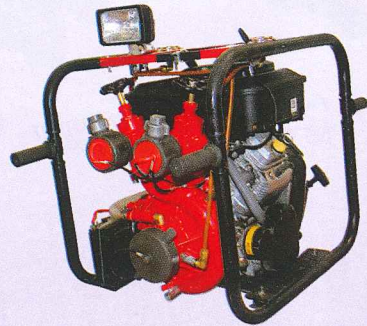

NFF-500
NFF-PU-500

NFF-700
NFF-PU-700

NFF-800
NFF-PU-800



Basket Strainer
NFF-ACC-BKS



Metal Suction Strainer
NFF-ACC-MSS



PVC and Rubber Suction Hose
NFF-ACC-PSH/RSR



Fireman Axe
NFF-ACC-AXE



Belt & Pouch
NFF-ACC-BLT

Hose maintenance Equipments

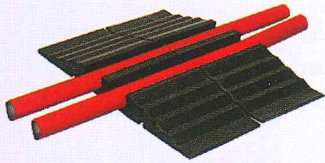

Hose Ramp
NFF-HME-HRP



Hose Washing Machine
NFF-HME-HWM

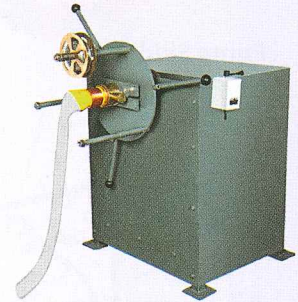

Electrical Hose Binding Machine
NFF-HME-EHBM

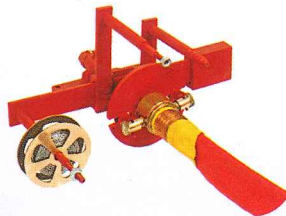

Manual Hose Binding Machine
NFF-HME-MHBM

Miscellaneous Equipments

Warning Appliance



Hand Operated Siren
NFF-SRN-HO



Fire Bell
NFF-SRN-FB



Electric Siren
NFF-SRN-EO



Smoke Generator
NFF-SGN

Skid Mounted Equipments



**DCP Skid
NFF-SME-DCPS**



**DCP Skid
NFF-SME-DCPS**

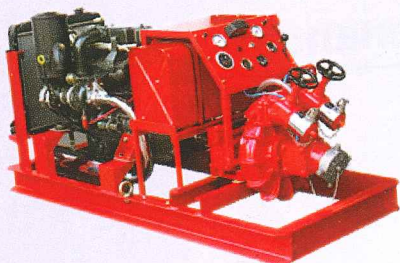

**Pump Skid
NFF-SME-PS**

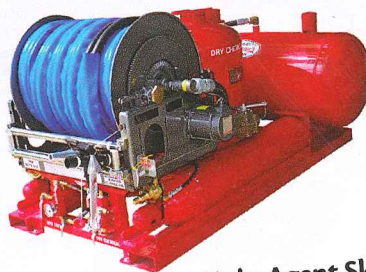

**Twin Agent Skid
NFF-SME-TAS**



**Foam Skid with Inline Balance
Proportioning System
NFF-SME-FS**



Foam Skid (Tank - 36000 Ltr.)



Foam Skid (Tank - 2500 Ltr.)

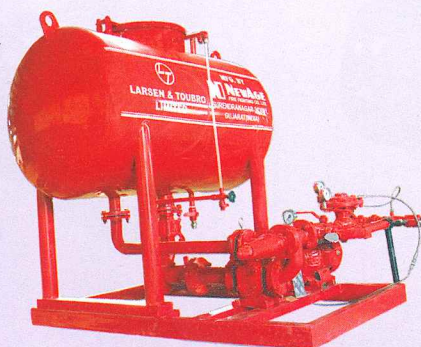

Foam Skid (Tank - 800 Ltr.)



Inline Balance Proportioning System

Smoke Extractor & Blower

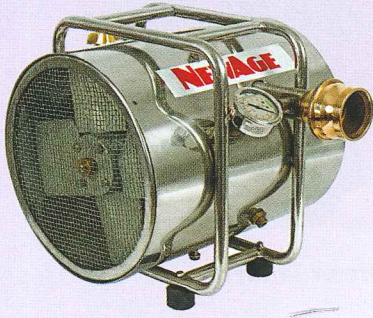

Water Driven
NFF-SET-WD



Electric Driven
NFF-SET-ED



Engine Driven
NFF-SET-EGD

Rescue Equipments

Hydraulic Tools

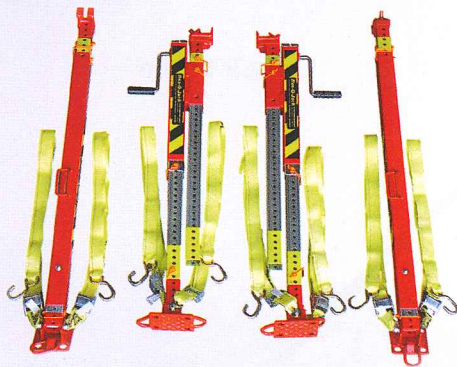

Stabilizers
NFF-RE-S



Rescue Platform
NFF-RE-RP

Lifting Tools



Low Pressure Lifting Bags
NFF-LT-LPLB



High Pressure Lifting Bags
NFF-LT-HPLB

Fire Vehicles



Foam Tender



Water Tender



Mini High Pressure Tender



DCP Tender



Multi Purpose Tender



Water Foam Boom Tower



Water Bauser Tender



Rescue and Hazmat Tender



Foam Nurser



Cabin Extensions



Refinery Fire Truck



Multipurpose Tender

Special Purpose Vehicles



Hydraulic Platform



Rescue Vehicle with Crane



Hazmat

Head Office & Factory

NewAge Fire Fighting Co. Ltd.
Ambawadi Industrial Estate,
Surendranagar - 363001 Gujarat, India
Phone: +91 2752 288000
Fax: +91 11 6617 3355

Export Office

513, Amanora Chambers,
East Amanora Park Town,
Hadapsar, Pune - 411028
Phone: +91 2067278500

